

# Passive Infrastructure – Technical Specification

# Contents

<b>INTRODUCTION</b>	3
<b>SERVICE OVERVIEW</b>	4
HIGH LEVEL DESIGN	4
OPTIONS	8
<b>CONTACTS</b>	12

# Introduction

Heathrow has been the busiest international hub airport in the world for the past decade, handling more than 60 million passengers on an annual basis. In order to successfully cater for such an extraordinary high volume of traffic, the airport operation must be based on using a robust groundwork, providing a reliable, uninterrupted service. The IT infrastructure at Heathrow has been built to meet these challenging criteria, and is being constantly upgraded to adopt the latest innovations and standards. It has proven to be well designed to handle the daily routine operation, as well as to cope with unexpected events.

Now, all the Heathrow airport tenants may benefit from this powerful IT infrastructure, commonly with the airport operations teams. Modern, resilient, built for purpose - all at the fraction of the costs for which it has been put in place.

The essential element of the Heathrow common infrastructure is the cabling. It's the cabling that is connecting the entire campus, spread through the miles of wiring laid in the ceilings and floors, terminating at some 120,000 ports. Using only high quality components, compliant with the industry standards, HAL provide a reliable and stable service making sure your data is safely delivered across the airport.

# Service Overview

Put simply, the Passive Infrastructure service is based on usage of network cabling to physically connect two points located at Heathrow Airport. This can be done in multiple ways, depending mainly on the distance between those two locations, and on the speed the data shall be transferred across. For short distances, cost effective horizontal copper cabling is used; for longer distances, powerful fibre optic cabling is used to prevent loss of signal. More details about each technology are described further in this document.

The main opportunity for using the passive infrastructure comes when tenants have their own active network equipment hosted in the Communication Rooms located in various Heathrow airport buildings. The passive infrastructure then provides connection between such Communication Rooms and a destination port at the Customer's site, or a connection between two Communication Rooms.

## HIGH LEVEL DESIGN

The cabling at Heathrow has been deployed systematically, with the focus on the most efficient use of the available capacity and on the simplicity of the installed wiring structures. The overall strategy and policies applied to the cabling are based on the concept of sharing the common infrastructure. In those HAL premises where common infrastructure has not been deployed, the design and delivery process will consider the specific local environment.

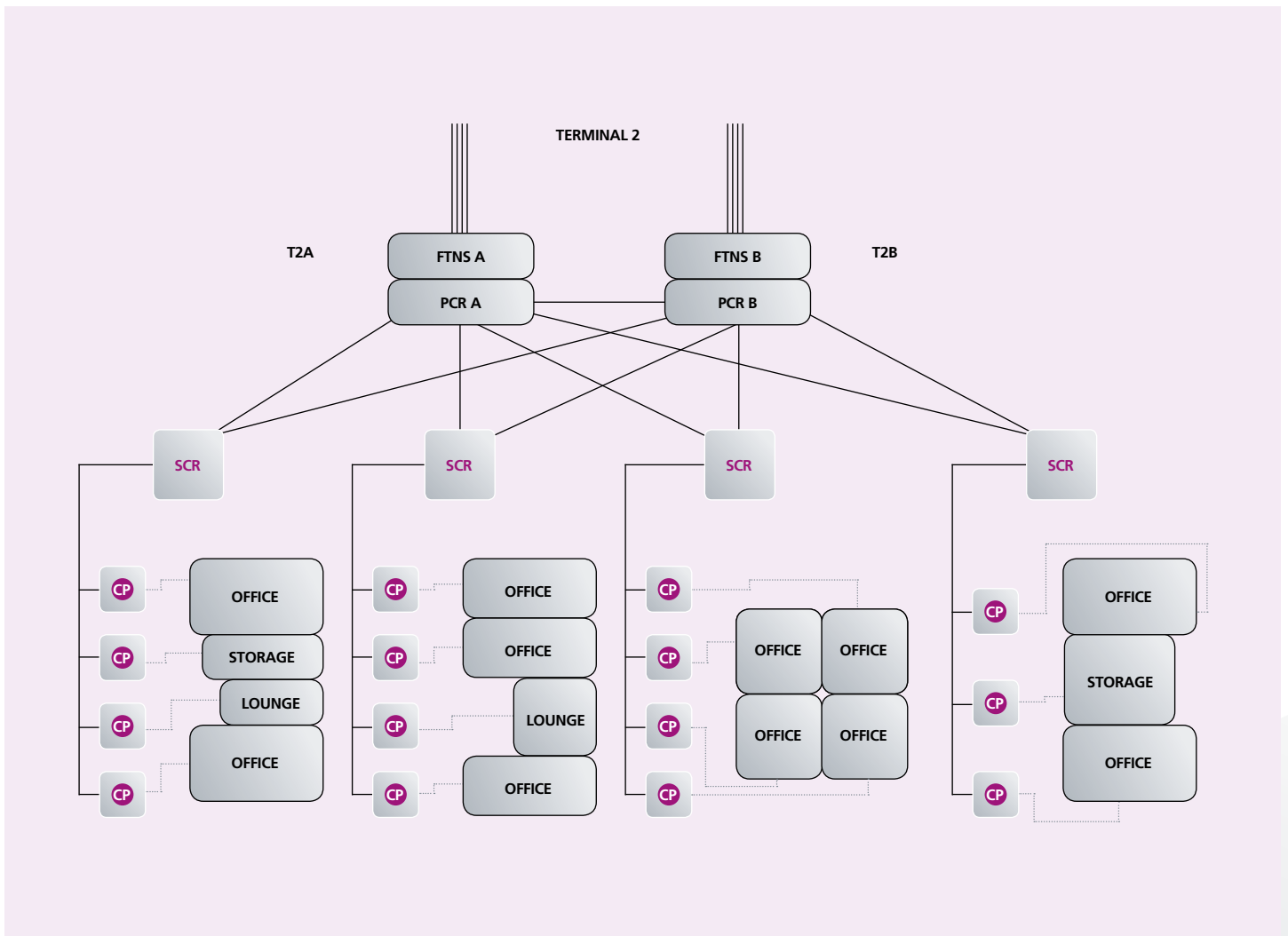

- FTNS (Fixed Telecoms Network Services), the single demarcation point for all external telecommunications providers who want to provide services at Heathrow Terminal 2. One FTNS is in T2A and another one in T2B.
- PCR (Primary Communications Room), main Communications rooms, one in T2A and T2B, located airside. These house core switching, routers and server applications. Physical resilience can be configured by using both PCRA & PCRB located in T2A & T2B respectively.
- SCR (Secondary Communications Rooms), multiple Communications rooms located more frequently across Terminal 2. House Access Layer switching, have 10U lockable compartments and are located to provide optimal coverage for the Cat6 structured cabling layout.
- CP (Consolidation Point), can serve one or more demises, has up to 12 data ports, and is what makes the Common Infrastructure as flexible as it is. For areas where a high number of ports are required, Heathrow can flood the areas with more CPs.

There are already links set up between the Communications Rooms and Consolidation Points – This is Common Infrastructure.

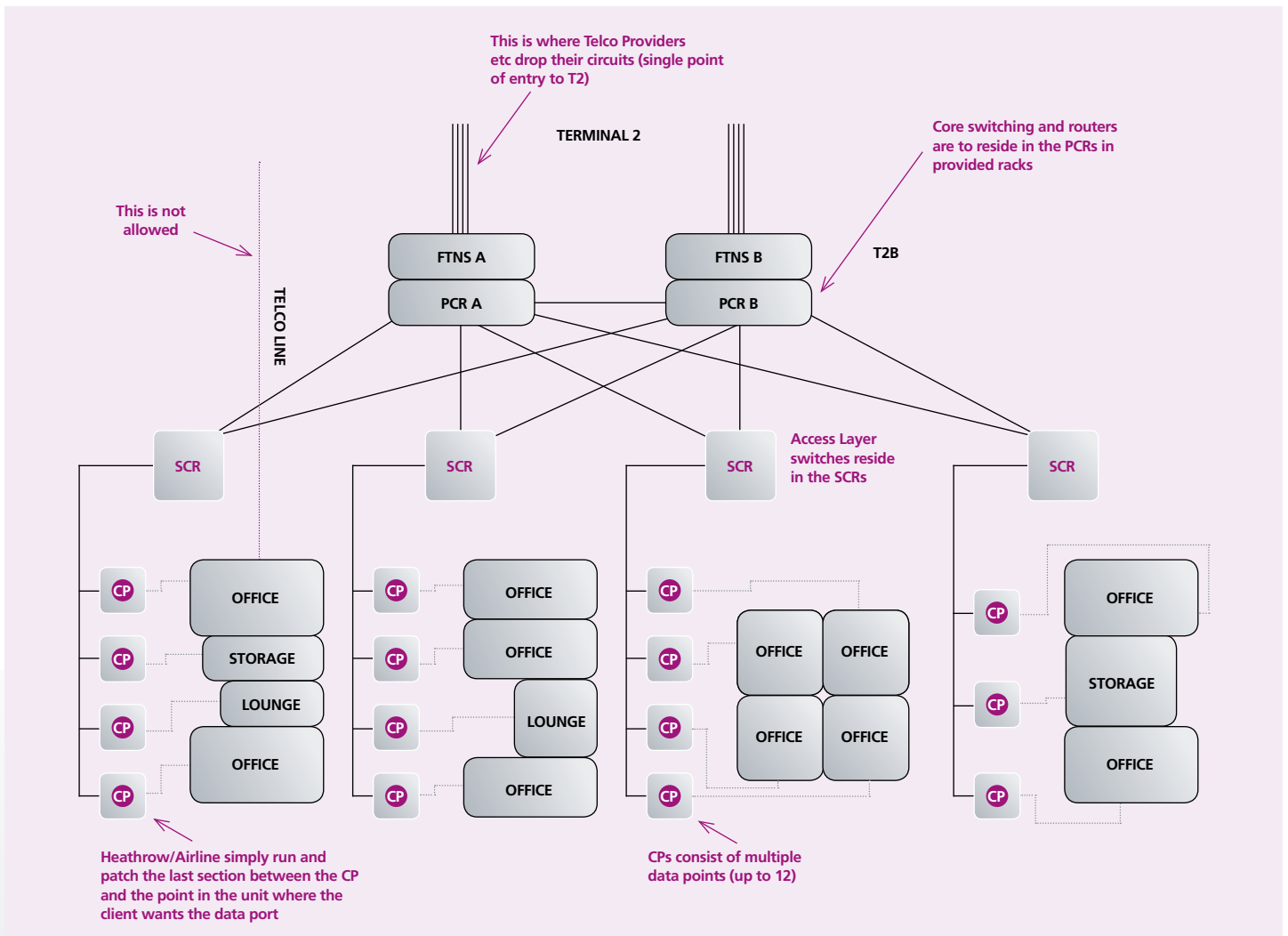

In all terminals, the Demarcation Point is defined as any two outlets between which the Passive Infrastructure connects. The exact point of demarcation is the female outlet of the Passive Infrastructure to which a subsequent connection is made (commonly referred to as the Channel link for Cat 6 cabling).

When a connection is required either between two Communications Rooms or between a Communications Room to a port destination within a Customer’s demised area, it will be provided as a single service, that is to say irrespective of the number of transitions or patching points, which might be required in order to provide the service all the way through.

Where the customer has a preferred supplier for the external connectivity, Heathrow will provide a fully supported infrastructure for a “Telco link” between the local FTNS room and the Customer’s demise. This can be done via fibre optic or Cat3 cabling, depending on what type of service has been brought from the provider chosen by the Customer.

The infrastructure for both of these services are already in place between the FTNS room and all SCR rooms, all that would be required is for the final cable run to be made from the SCR room to the customer demise. In some key locations, there are fibre optic and copper CP’s installed preventing the requirement to cable all the way back to the SCR.

The service can be delivered into the customer’s site either through copper Cat3 cabling on patch panel, installed into the customer’s cabinet or on a dual/quad RJ45 network socket. Or through a fibre optic on a patch panel installed into the customer’s cabinet or on a fibre optic work area outlet.

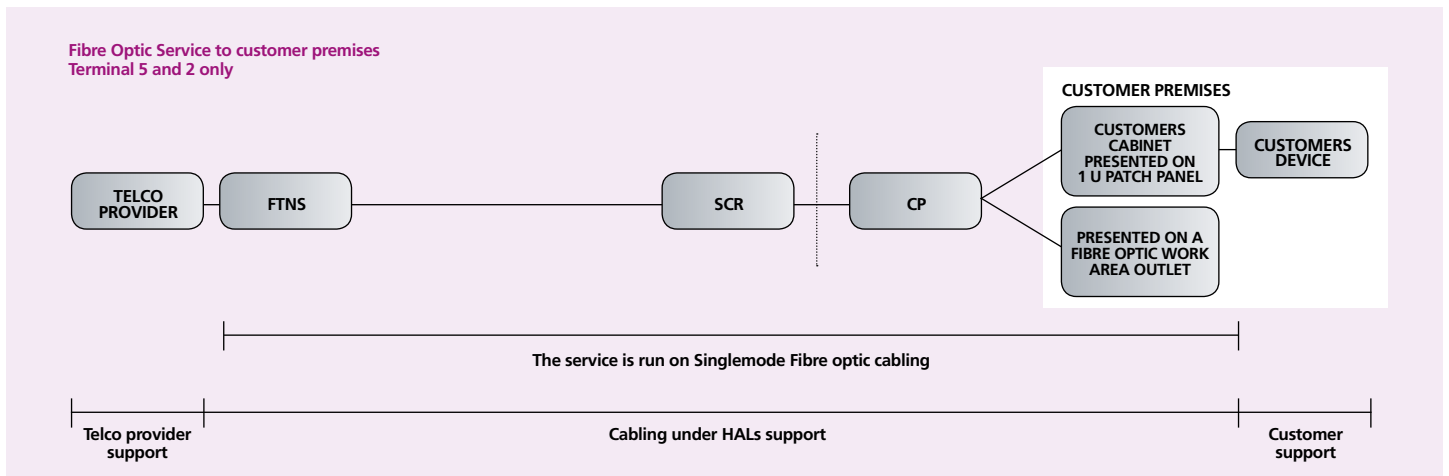
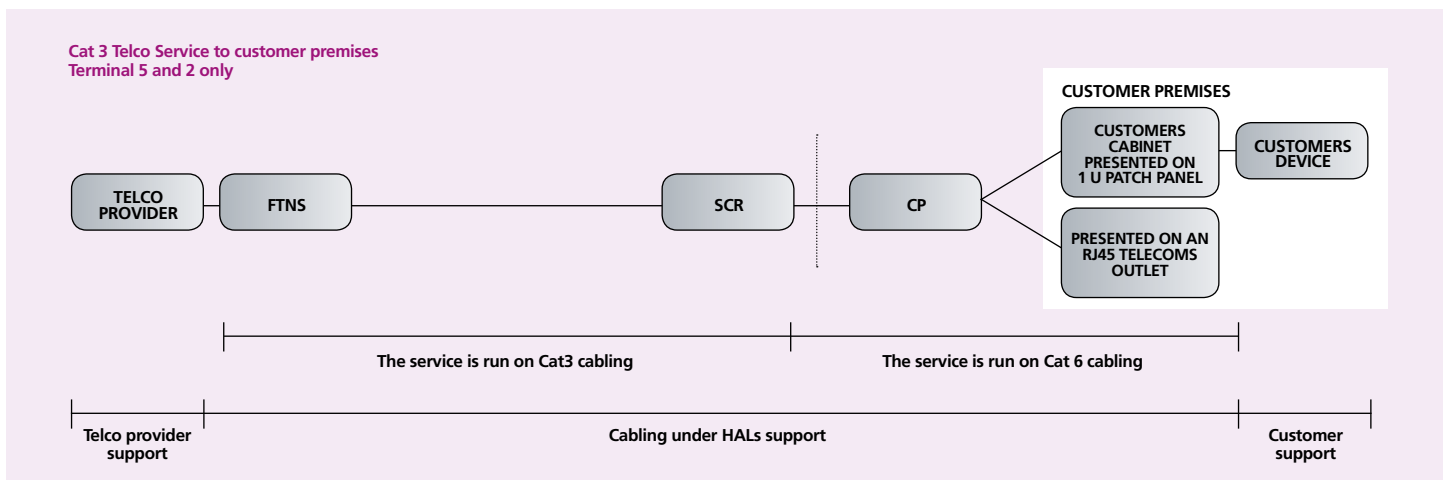

Where the Customer has multiple site locations across a Terminal and wants to use their own active devices, Customers can install a router or distribution device in the airline room / PCR. From there cable out from the location to the SCR over fibre optic to their own active equipment installed in one of the cabinet spaces reserved for commercial customers and then back over the Heathrow copper cabling to the end devices.

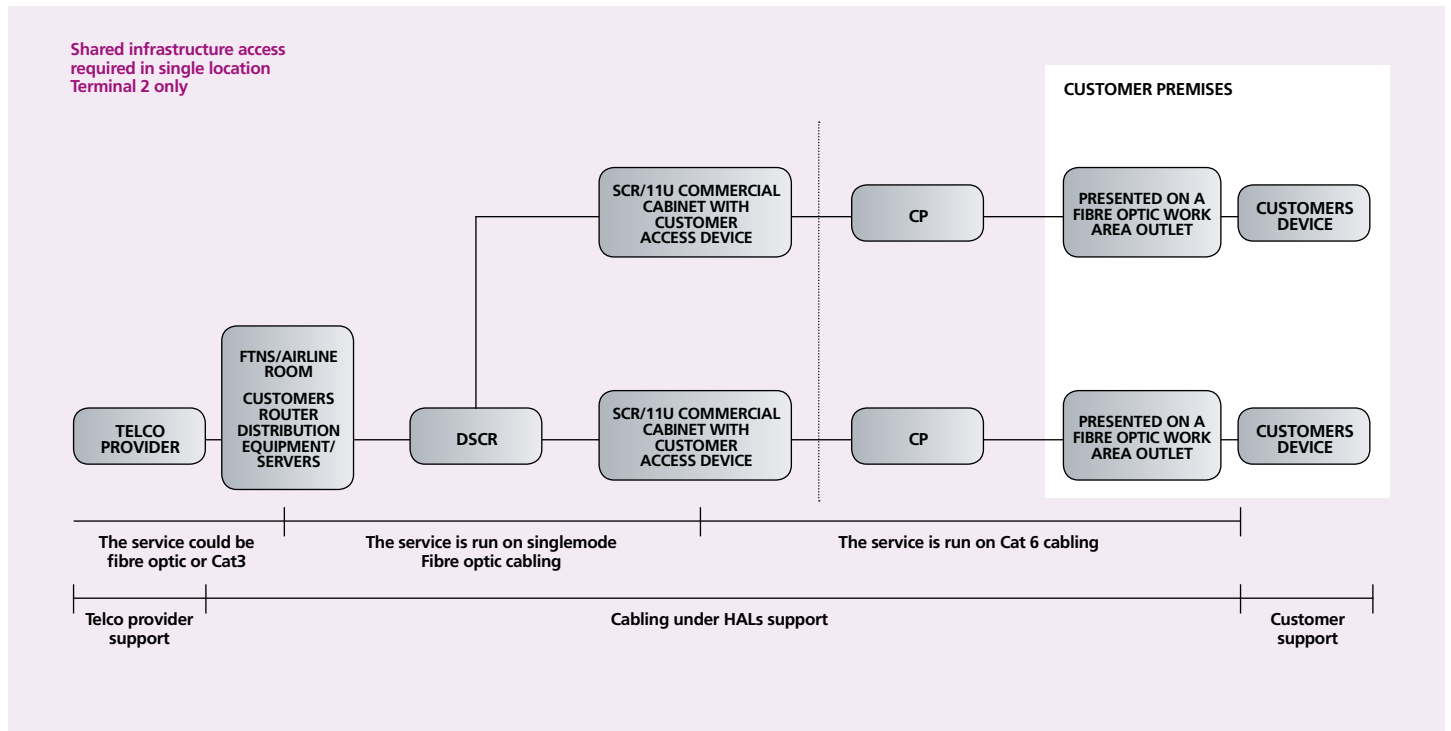

Where the Customer does not wish to install horizontal copper cabling in their premises and wish to use the Heathrow's copper cabling (as it may already be in place), the Telco service can be presented into one of the commercial cabinets located within the SCR and then the service runs to the end user over the Heathrow infrastructure.

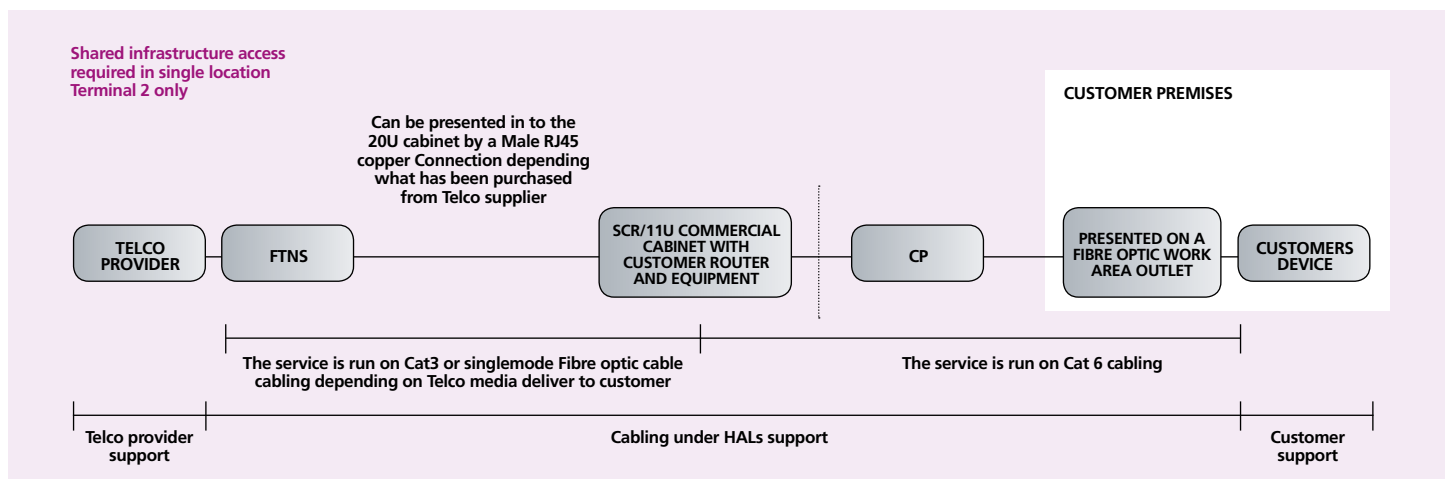

## OPTIONS

CABLING	CONNECTIVITY		
	Up to 90 meters within a building	More than 90 meters within a building	Between buildings
Copper	•		
Fibre	•	•	•

### Copper Cabling

Due to its physical characteristics, the copper-based cabling is used only within an area of a single building located at Heathrow Airport. As it can span across a single building level, it's often called horizontal cabling.

The maximum length that channel link can be run is 100 meters end to end, the last 5 meters are removed at either end for patch leads. This enables connection to end devices and cross patching, plus another 10 meters for switch looms / equipment cord that are used for the connection to network devices in the commercial and HAL cabinets. This means the maximum length a permanent link can be run is 80 meters.

To ensure that all deployments are kept within this standard, a patch lead at the customer end or in the SCR / DSCR over 5 meters will not be provided.

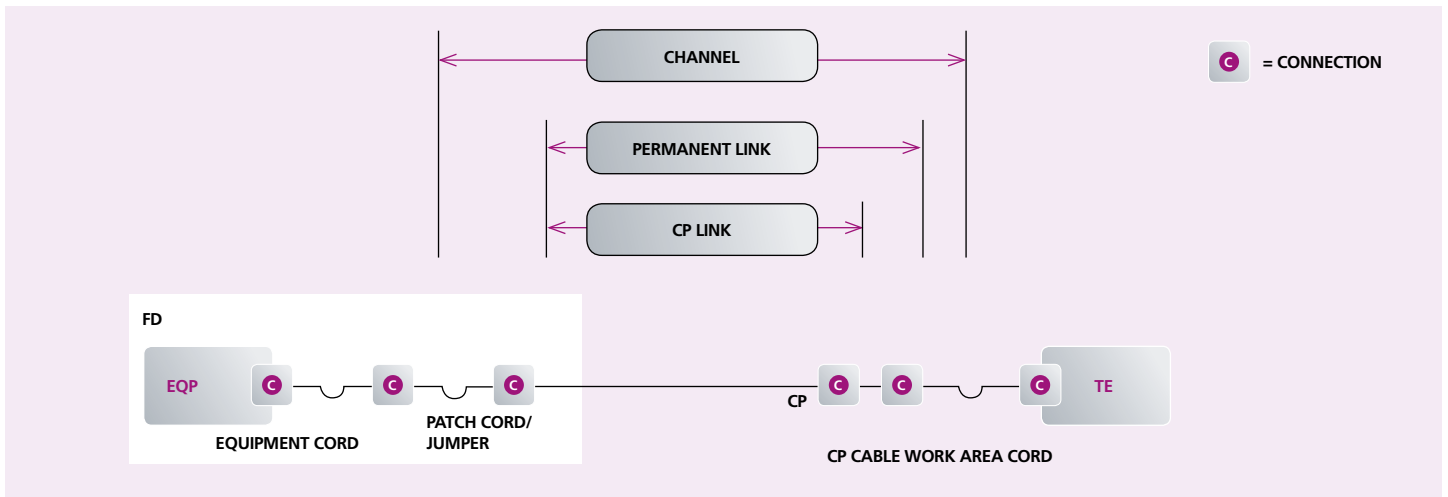

For an area where the location of the Consolidation Point is unknown to the Customer, a survey will be performed to determine what kind of cabling is available for the given case.

For T1/3/4/5 where a port already exists and is not used, this can be patched as needed. For T2, Heathrow provided infrastructure within a Customer's own demise includes four dual network outlets per 10 square meter of accommodation.

In T2 and T5 all installations have achieved a standard sufficient enough for a 25 year TrueNet warranty to be issued. In all other terminals the minimum installation standard is to achieve a 20 year Truenet warranty.

Heathrow Passive infrastructure conforms to EN 50173 and EN 50174 standards to support a wide variety of communication protocols. The standard installation for internal runs is UTP LSZH and UTP PVC for external runs. STP can also be requested and is used in areas that may have high interference, such as baggage sort areas.

### Cat3 Specifications

The Cat3 cabling at Heathrow is primarily used to deliver the copper solution Telco services, between the FTNS location and an SCR. The continuation of this service will then be run over the Horizontal cabling (Cat5e or Cat6 depending on location) from the SCR to final destination, be it a commercial cabinet using the switch loom or a telecoms outlet at the customer's premises.

The Cat3 cabling installed at Heathrow is a multi pair cable. For internal runs the CW1308 with a jacket construction of Low Smoke Zero Halogen (LZOH) is used, while the CW1128 is for the external runs with over voltage modules installed at one end of the cable run.

The Cat3 cabling is presented in the FTNS on a wall frame utilizing Series II blocks (237A), so the Telco service can be connected with a jumper wire and in the SCR / DSCR rooms on 25 way RJ-45 ADC Krone voice patch panels (1 pair per port), which are installed in the high density patching frames (HDPF) to enable cross patching to the Horizontal cabling with a standard straight through patch leads.

All of the Cat3 backbone cabling is tested on installation for continuity and installation resistance.



## Cat5e Specifications

Cat5e was the chosen cable to be used for the copper cabling prior the construction of T5, therefore can be found in the older buildings and Terminals.

ADC Krone TrueNet UTP with the following features is currently being used for the deployment:

- Covered by the TrueNet® System Warranty
- Conductor 24 AWG solid bare copper
- Insulation 100% polyolefin
- Jacket Low Smoke Zero Halogen
- Nominal outside diameter 5.0mm
- DC Resistance unbalanced 2%
- DC Resistance at 20 degrees C 9.38 W/100m
- Mutual Capacitance at 20 degrees C 5.6nF / 100m
- Operating Voltage (max) 300 V DC
- Worst Case cable skew 22 ns / 100m
- Nominal Velocity of propagation 67%
- Operating Temp Range -20° to 75°C
- Installation Temp 4° to 50°C
- Transportation Temp -20° to 75°C
- Conforms to ISO/IEC 11801, EN50173-1 and IEC 60332-1

## Cat6 Specifications

Cat 6 is now the horizontal cable of choice and is used in all new building installs. Cat6 can be found in all of T5 and out buildings and in T2.

ADC Krone TrueNet UTP with the following features is currently being used for the deployment:

- Conductor 24 AWG solid bare copper
- Insulation 100% polyolefin
- Separator 100% polyolefin
- Jacket Low Smoke Zero Halogen
- Nominal outside diameter 6.0mm
- DC Resistance unbalanced 2%
- DC Resistance at 20 degrees C 9.38 W/100m
- Mutual Capacitance at 20 degrees C 5.6nF / 100m
- Operating Voltage (max) 300 V DC
- Worst Case cable skew 25 ns / 100m
- Nominal Velocity of propagation 69%
- Operating Temp Range -20° to 75°C
- Installation Temp 4° to 50°C
- Storage Temp -20° to 75°C
- ISO/IEC 11801:2002 2nd edition (ref: IEC 61156 series) ANSI/TIA/EIA 568-B.2.1 EN 50173:2002 (ref: EN 50288 series)

## CAT5e and Cat6 presentation

The horizontal presentations at the Customer premises are made with a female RJ45 connection and terminated to T-568B. The horizontal runs within an SCR or DSCR are terminated on one of two types of ADC Krone TrueNet patch panels:

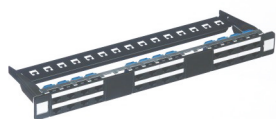

1U 24 way TrueNet PCB UTP patch panel for Cat5e



1U 24 way Modular KM8 Patch panel for Cat6



At the Telecoms Outlet (TO) the horizontals can be presented in a number of ways, depending on the customer requirements and location. The standard presentation for Cat5e is ADC Krone category 5e LN UTP faceplate in a double or quad variant, surfaced mounted, wall mounted or installed into trunking.



For Cat6, the ADC Krone UK style faceplate and adaptors are used. These are also available in a double or quad variant and asle can be installed in the same way as the Cat5e outlets. If the outlet is to be installed into an industrial area, then a metal back box and face plate is used.

The other options available are for the cables to present on to another patch panel in the Customer's cabinet located in their premises, or for the outlets to be presented onto a pod system. The pod system is a metal box / pod and comes in a different number of outlet configurations, which can accept either Cat5e or Cat6 cabling and adaptors. The pod exits the floor via a grommet on a length of flexible conduit. This pod is then secured in an accessible location like under a desk or till area and can provide multiple connectivity. This solution is suitable mainly for offices as it provides the advantage of having more flexibility for the desk moves.

## Copper Testing

All the copper horizontal cabling is tested in accordance with and to EN50173:2002 (2) standard or those agreed with ADC KRONE to maintain their warranty.

The test is carried out with a Fluke DTX and the data must meet or exceed the limit value determined in EN50173-1:2002 (2).

The following checks are carried out during the testing process:

- Wire map
- Length
- Delay Skew
- Insertion Loss (Attenuation)
- NEXT Loss – pair to pair
- PSNEXT Loss
- ELFEXT Loss, pair to pair
- PSELFEXT Loss
- Structural Return loss
- Return loss
- ACR (Attenuation to cross Talk Ratio)
- PSACR
- Propagation Delay

The permanent link is only tested on installation, as all cross connection patch leads are pre tested and made by the approved manufacturer. The Channel test is only carried out when a fault condition occurs.

## Fibre Optic Cabling

Fibre optic connections are typically used for connections for longer distances, like between Communications Rooms at different terminals or at other buildings within Heathrow. As there is currently fibre optic cabling spanning across all of the Heathrow estate, every active cabinet in SCR, DSCR, and FTNS has the ability to connect to each other over single mode fibre optic cabling. This is valid also for any ACP (Active Consolidation Point), which is a cabinet or group of cabinets that are not located in a comms room.

### General Characteristics

- Single-mode fibre
- 9/125 micron step index
- Dual window (1310/1550 nm)
- All fibre optic routes are designed to have a maximum loss of 4 dB or less
- Core counts: 12, 24, 48, 96, 144
- LC fibre connector is the standard
- All terminations are fusion spliced of pigtails onto incoming fibre cables

### Fibre Optic Cabling Presentation

Within all the comms rooms, the fibre is presented on to an ODP (Optical Distribution Panel) with a female LC connection, while the cross patching is carried out with male LC fibre optic patch leads. The ODP is a 1U panel which can accept up to 48 LC connections.

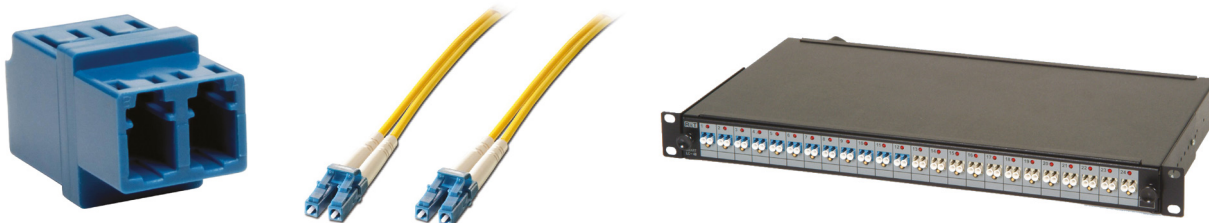

Fibre to be delivered to the Customer premises can be carried out in two different ways; either to have an ODP installed into the customers cabinet located within their demise, or to use a Fibre to the desk – Fibre optic wall outlet, which works the same as a Copper TO, but with a fibre. Both of these solutions are presented with a female LC connection.

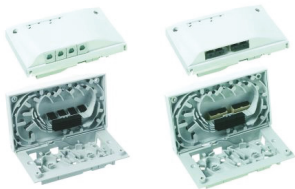

### Fibre Optic Cabling Testing

All Fibre optic cabling is tested in accordance with and to ISO/IEC 14763-3 standard or those agreed with ADC KRONE to maintain their warranty.

The test is carried out with a Fluke DTX and OTDR (Optical Time Domain Reflectometer) while the data must always meet or exceed the limit value determined in ISO/IEC 14763-3.

On the installation of any new cabling, 1 core is tested before the cable is pulled off the drum to confirm the length and quality of the cable. Once the cable has been installed all terminated cores will be tested in both directions with an OTDR to confirm continuity and ensure that all connections are within the standards

When a new circuit is installed to create a channel link, the circuit will be tested with a Fluke DTX to ensure that the channel link is still within and meets the required standards stated by Krone.

All cross connection patch leads are pre manufactured by an approved manufacturer and tested before being installed on site. Fibre optic cross connection leads are never made on site.

# Contacts

Contact: 0208 756 8545  
Email: [Heathrow@sita.aero](mailto:Heathrow@sita.aero)  
Contact Address: Compass Centre, Nelson Road, Hounslow,  
Middlesex, TW6 2GW

Heathrow Airport Common Infrastructure Policy (CIP) and Heathrow Airport Limited reserves all of its rights and remedies in respect of the CIP including but not limited to those rights relating to scope, application and enforcement. The rights and remedies set out in the CIP are in addition to, and not exclusive of, any rights or remedies provided by law.

This document and the information contained therein are confidential and remains the property of Heathrow Airport Limited. The document may not be reproduced or the contents transmitted to any third party without the express written consent of Heathrow Airport Limited. This document and information contained therein is subject to contract.